



DW80K7050 Series
DW80K5050 Series
DW80R5060 Series
DW80R5061 Series

Dishwasher user manual

imagine the possibilities

Thank you for purchasing this Samsung product.



SAMSUNG

contents

SETTING UP YOUR DISHWASHER

6

- 6 Unpacking your dishwasher
- 6 Checking parts
- 7 Control panel
- 9 Cycle selector
- 10 Meeting installation requirements

USING YOUR DISHWASHER

11

- 11 Basic guidelines
- 14 Adjusting the angle of the plate supports
- 15 Adjusting the height of the upper rack
- 15 Removing the upper rack
- 16 Loading the lower rack
- 17 Loading the upper rack
- 18 Using the cutlery rack
- 19 Using the 3rd (cutlery) rack
(For applicable models)
- 20 Using detergent

CLEANING AND MAINTAINING YOUR DISHWASHER

22

- 22 Cleaning the exterior
- 22 Cleaning the interior
- 22 Cleaning the filters (DW80K7050 series)
- 23 Cleaning the nozzles
- 24 Storing your dishwasher

CYCLES

25

- 25 Cycle chart

TROUBLESHOOTING

27



- 27 Check these points if your dishwasher...
- 30 Information codes

APPENDIX

31











- 31 Helping the environment
- 31 Specifications

safety information

Throughout this manual, you'll see Warning  and Caution  notes. These important safety instructions do not cover all possible situations that might occur. It is your responsibility to use caution when installing, maintaining, and operating your dishwasher. Samsung will not be liable for any damage resulting from improper use.

IMPORTANT SAFETY INSTRUCTIONS

What the icons and signs in this user manual mean :

 WARNING	Hazards or unsafe practices that may result in severe personal injury or death .
 CAUTION	Hazards or unsafe practices that may result in personal injury or property damage .
 CAUTION	To reduce the risk of fire, explosion, electric shock, or personal injury when using your dishwasher, follow these basic safety precautions:
	Do NOT attempt.
	Do NOT disassemble.
	Do NOT touch.
	Follow directions explicitly.
	Unplug the power plug from the wall socket.
	Make sure the machine is grounded to prevent electric shock.
	Call the service center for help.

WARNING

Cancer and Reproductive Harm-www.P65Warnings.ca.gov.

WARNING - When using the dishwasher, follow basic precautions, including the following:

 Read all instructions before using the dishwasher.

As with any equipment using electricity, water, and moving parts, potential hazards exist.

Use the dishwasher only for its intended function.

Use only detergents or wetting agents recommended for use in a dishwasher, and keep them out of the reach of children.



When loading items to be washed:

- Locate sharp items so that they are not likely to damage the door seal, and
- Load sharp knives with the handles up to reduce the risk of cut-type injuries.

SAVE THESE INSTRUCTIONS

English - 3

safety information

-  Do not wash plastic items unless they are marked “dishwasher safe” or the equivalent. For plastic items not so marked, check the manufacturer’s recommendations.
-  Do not touch the HEATING ELEMENT during or immediately after use.



WARNING : When using your dishwasher, follow basic precautions, including the following:

1. Read all instructions before using the dishwasher.
2. Use the dishwasher only for its intended function.
3. Use only detergents or wetting agents recommended for use in a dishwasher and keep them out of the reach of children.
4. When loading items to be washed:
 - locate sharp items so that they are not likely to damage the door seal, and
 - load sharp knives with the handles up to reduce the risk of cut-type injuries.
5. Do not wash plastic items unless they are marked “dishwasher safe” or the equivalent. For plastic items not so marked, check the manufacturer’s recommendations.
6. Do not touch the HEATING ELEMENT during or immediately after use.
7. Do not operate your dishwasher unless all ENCLOSURE panels are properly in place.
8. Do not tamper with the controls.
9. Do not abuse, sit on, or stand on the door or on a dish rack of the dishwasher.
10. To reduce the risk of injury, do not allow children to play in or on the dishwasher.
11. Under certain conditions, hydrogen gas may be produced in a hot-water system that has not been used for two weeks or more. **HYDROGEN GAS IS EXPLOSIVE**. If the hot-water system has not been used for such a period, before using the dishwasher, turn on all hot-water faucets and let the water flow from each for several minutes. This will release any accumulated hydrogen gas. As the gas is flammable, do not smoke or use an open flame during this time.
12. Remove the door to the washing compartment when removing an old dishwasher from service or discarding it.

After unpacking the dishwasher, keep the packaging out of the reach of children.

The dishwasher is extremely heavy. Do not attempt to move or carry the dishwasher by yourself. Two or more people are needed to move a dishwasher and avoid potential injuries.

Do not install the dishwasher near electrical components. Keep the dishwasher away from open flames.

Install and level your dishwasher on an uncarpeted floor that can support its weight.

Your dishwasher must be properly grounded. Never connect it to an ungrounded outlet. See page **10** for more information on grounding your dishwasher.

Connect the ground wire to the green ground connector in the terminal box.

After the dishwasher is installed, check that the drain hose is properly connected and that there is no leakage from the hose connectors. If the drain hose is loose, it may cause property damage.

The water supply line is susceptible to breakage. As time goes by, it becomes less flexible. Check the line periodically. If it is swollen, torn, cut, or there is a water leak, replace it immediately.

SAVE THESE INSTRUCTIONS

English - 4

To safely operate this appliance, familiarize yourself with its operations and exercise care when using it.

Do not put gasoline, solvents, or other flammable materials inside the dishwasher. Do not wash dishes exposed to these materials.

Keep your dishwasher detergent out of the reach of children. Detergent has an adverse effect on human organs. It contains elements for polishing and is corrosive. Avoid letting the detergent come into contact with your skin and eyes.

Do not push or place pressure on the door when it is open, as this may damage the dishwasher or cause harm.

Do not allow children to play in or on the dishwasher. They may harm themselves or damage the dishwasher.



Disconnect the power cable (or set the circuit breaker to off) before servicing your dishwasher.

Do not repair, replace, or service any part of your dishwasher yourself. Disassembly, repairs and modifications must be performed by authorized service technicians only. Work done by an unauthorized person may void your warranty.

Before disposing of your dishwasher, remove the door of the washing compartment or the door latch so that children or small animals do not get trapped inside.

If the dishwasher is left unused for an extended period of time, turn off the water supply.

This dishwasher is intended for residential use only.

BEFORE USING YOUR DISHWASHER



WARNING



Tip-Over Hazard

- Do not use the dishwasher until it is correctly installed.
- Do not push down on an open door.
- Do not place excessive weight on the open door.



Electric Shock Hazard

Failure to follow these instructions can result in death, fire, or electric shock:

- Electrically ground the dishwasher
- Connect the ground wire to the green ground connector in the junction box.
- Do not use an extension cord.

SAVE THESE INSTRUCTIONS

English - 5

setting up your dishwasher

Be sure to have your installer follow these instructions closely so that your new dishwasher works properly and that you're not at risk of injury when washing dishes.

UNPACKING YOUR DISHWASHER

- Once your new dishwasher has been delivered to you, carefully unpack it and check for any damage. If the dishwasher has been damaged, make note of it on the waybill and keep a copy. Do not install the dishwasher, and contact Samsung Customer Service at the number listed below.
- If there is no damage to the product, you can proceed with the installation. If you are going to install it yourself, make sure to read through the installation guide and follow the directions inside.
- After unpacking your dishwasher, keep the packaging out of the reach of children to ensure their safety.

CHECKING PARTS

When your dishwasher has been unpacked, make sure you've received all the parts shown below. If your dishwasher was damaged during shipping, or if you do not have all the parts, contact **Samsung Customer Service at 1-800-SAMSUNG (726-7864)**

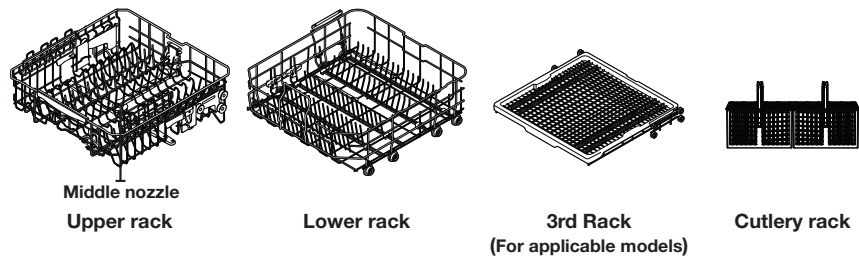
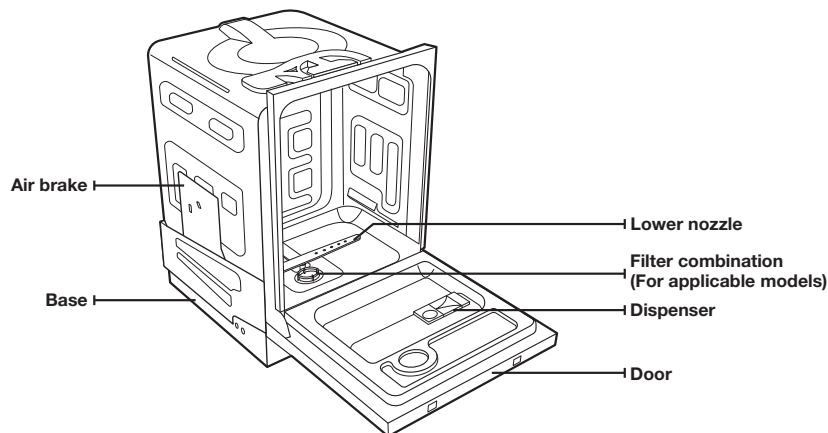



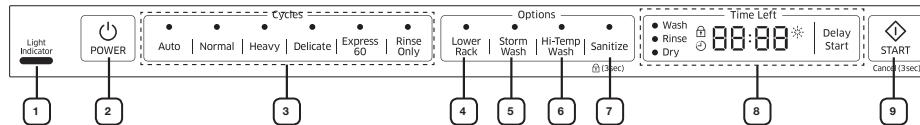

 Accessory parts - User/Installation manual, Installation Kit.

CONTROL PANEL

DW80K7050, DW80K5050, DW80R5060, DW80R5061 Series



1	Light indicator	Indicates that the product is operating.
2	Power	When you press the Power button, the entire display turns on and off, and then the light of the most recently finished cycle lights up. When the selected cycle is complete, the dishwasher powers off automatically.
3	Cycle Selector	Select the appropriate wash cycle depending on the soil level of your dishes. After you select a cycle, the Cycle On light for that cycle lights up.
4	Lower Rack	Select this option to wash a small load of dishes. We recommend that you place dishes in the lower rack when you use this feature.  When you select Lower Rack , the dishwasher will not wash dishes placed in the upper rack.
5	StormWash™	Use this option when you want to wash pots and pans, durable serving bowls, and other large, very dirty, hard to clean dishes. To use StormWash™ , place the dishes face down in the marked StormWash™ area in the lower basket.  StormWash™ is not available with the Delicate and Rinse only cycles.
6	Hi-Temp Wash	Raises the main wash temperature to improve cleaning for loads containing tough, baked-on food.  Hi-Temp Wash is not available for the Delicate and Rinse only cycles.
7	Sanitize / (3sec) (Control Lock)	The temperature rises to 163 °F (73 °C) in the final rinse cycle for high temperature sanitization. If you select the Sanitize option, the “Sanitize” lamp blinks when the water temperature reaches the sanitary temperature (over 155 °F (68 °C)), and then remains illuminated until the Sanitize option ends. When you press the Power button, the “Sanitize” lamp turns off.  Sanitize is not available for the Delicate and Rinse only cycles.  The Sanitize feature operates in accordance with NSF/ANSI Standard 184 for Residential Dishwashers. Certified residential dishwashers are not intended for licensed food establishments. Your dishwasher is NSF Certified. Only the Normal cycle with the Sanitize option has been designed to meet the requirements for soil removal and sanitization efficacy in NSF 184.

setting up your dishwasher

<p>7 Sanitize / (3sec) (Control Lock)</p>	<p>Control Lock allows you to lock the buttons on the control panel so children cannot accidentally start the dishwasher by pressing the buttons on the panel.</p> <p>To lock and unlock the buttons on the control panel, hold the Sanitize button down for three (3) seconds when power is On.</p>
<p>8 Delay Start (DISPLAY)</p>	<p>Delay a cycle for up to 24 hours in one-hour increments. The hour displayed indicates the time at which the wash will be started.</p> <p>Displays wash information, Delay Start hours, and Error messages.</p> <p>If an trouble occurs during an operation, an check message is displayed with a warning sound. Refer to “Information codes” on page 30.</p>
<p>9 Start</p>	<p>To start a cycle, press the Start button before closing the door.</p> <p>To cancel the cycle, press and hold the Start button for 3 seconds or press the Power button to power off.</p>

- ☞ You can select options (**Lower Rack**, **StormWash™**, **Hi-Temp Wash**, **Sanitize**) before starting a cycle. If you change the cycle after selecting an option, the original cycle is reset.
- ☞ To prevent the touchpad from losing response sensitivity, follow these instructions:
 - Touch the center of each keypad using one finger. Do not push.
 - Clean the touch control's surface regularly with a soft, damp cloth.
 - Be careful not to touch more than one touch key pad at a time, except as directed.
- ☞ When you pause a cycle by opening the door during operation, press the **Start** button before closing the door to continue the cycle.
Push door firmly closed within 3 seconds of pressing **Start** button.
If the door is not closed within 3 seconds, the cycle will not start.

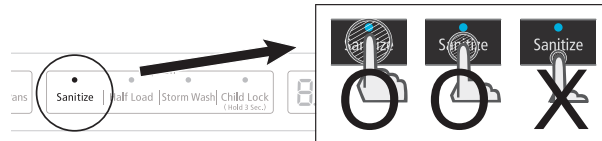

CYCLE SELECTOR

DW80K7050, DW80K5050, DW80R5060, DW80R5061 Series

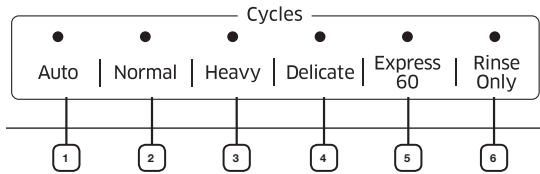

1	Auto	This cycle detects the level of soil and automatically initiates the optimal cycle after a few minutes of operation.
2	Normal	Use this cycle for normally soiled dinner dishes.
3	Heavy	Use this cycle for heavily soiled dishes and dishes with heavy soil.
4	Delicate	Use this cycle for normally soiled dishes or fragile items such as glasses.
5	Express 60	Use this cycle for lightly soiled dishes.
6	Rinse only	Use for rinsing dishes, glasses, and silverware that will not be washed right away. Do not use detergent.

setting up your dishwasher

MEETING INSTALLATION REQUIREMENTS

Electrical supply and grounding



To prevent the risk of fire, electric shock, or personal injury, all wiring and grounding must be done in accordance with the National Electrical Code ANSI/FNPA, No. 70 Latest Revision and local codes and ordinances. It is the personal responsibility of the appliance owner to provide adequate electrical service for this appliance.



Never use an extension cord.

CAUTION

When preparing for installation, ensure that you provide:

- An individual branch circuit with a 120 V, 60Hz, 15 AMP fuse or circuit breaker that serves only your dishwasher .

Your dishwasher must be grounded. If your dishwasher malfunctions or breaks down, grounding will reduce the risk of electric shock by providing a path of least resistance for the electric current.



WARNING

Never connect the ground wire to plastic plumbing lines, gas lines, or hot water pipes.

GROUNDING INSTRUCTIONS

For a permanently connected appliance:

This appliance must be connected to a grounded metal, permanent wiring system, or an equipment-grounding conductor must be run with the circuit conductors and then connected to the equipment-grounding terminal or lead on the appliance.

Water supply

The hot water supply line pressure must be between 20-120 psi (140-830 kPa).

Adjust the water heater to deliver water between 120 °F (49 °C) - 149 °F (65 °C).



Most plumbing supply stores sell water supply lines of various lengths up to 10 feet (305 cm) long.

You can reduce the risk of leaks and water damage by:

- Making water faucets easily accessible.
- Turning off faucets when the dishwasher is not in use.
- Periodically checking for leaks at water supply line fittings.



WARNING

Before using your dishwasher for the first time, check all connections at the water supply valve and faucets for leaks.

Flooring



For safety, your dishwasher must be installed on a solidly constructed floor.

Never install your dishwasher on a platform or poorly supported structure.

Your dishwasher must be properly installed in accordance with the Installation Guide before you use it. If you did not receive an Installation Guide with your dishwasher, you can obtain one by visiting our website at www.samsung.com.

using your dishwasher

BASIC GUIDELINES

1. Open the door and load your dishes (see page 14).
 - Place dishes into the upper and lower racks, unless you have selected Lower Rack.
 - Remove any food remains from the dishes before placing them in the FlexLoad™ rack(s).
 - After placing the dishes into the FlexLoad™ racks, rotate the nozzles by hand to check whether any of the dishes will interfere with them.
 - Make sure the dishes will not prevent the detergent dispenser from opening.
 2. Add detergent to the dispenser (see page 20).
 - Make sure to use only automatic dishwasher detergent and rinse aid.
 - Refer to **“Using detergent”** on page 20 for instructions explaining how to add detergent and rinse aid.
 3. Press the **Power** button.
 - When you press the **Power** button, the entire display turns on and off, and then the indicator of the most recently finished cycle lights up.
 - If “Low Rinse” (☼) is illuminated, you should refill the rinse aid dispenser to improve washing and drying performance.
 4. Select an appropriate cleaning cycle depending on the soil level of the dishes. (See pages 9 and 25.)
 - Press the appropriate cycle button.
 - When you press a cycle button, the cycle indicator lights up.
 5. Press the **Start** button, and then close the door within 3 seconds.
 - The dishwasher will start draining after a few seconds, and then start the selected cycle.
 - Make sure to close the door firmly. If the door is not closed properly, the selected cycle will not start automatically.
 6. When the wash cycle is completed.
 - The light illuminates and the dishwasher sounds a chime.
 - The dishwasher powers off automatically.
 - The door opens automatically 5 ~ 15 minutes before the cycle ends to improve drying performance.
-  - If you want to load more dishes or pause the dishwasher while it is already running, make sure to open the door slowly and carefully as there is a possibility of injury from the hot steam inside the dishwasher.
- If the door is opened while the dishwasher is running, a safety mechanism is activated and stops the cycle.
 - To resume operation, press the Start button, and then close the door within 3 seconds.
 - Adding dishes several minutes after the dishwasher starts operating may affect its performance.
 - If you open the door while the dishwasher is running at high temperature, it will drain the hot water automatically to protect you from scalding.
-  You should use rinse aids for better drying performance. You can further improve drying performance by also selecting the Sanitize option.
-  After a cycle is complete, the door automatically opens to let steam out. This is normal and not a product malfunction.

using your dishwasher

Touch controls

Touch controls allow you to operate the dishwasher easily.

- They are convenient to operate, requiring only a soft touch.
- Have a simple and stylish design.
- Are easy to clean.

If you have children or you want to clean the Control Interface, we recommend activating the Control Lock feature to lock the control buttons. See page 8.

- Children will not be able to accidentally start the dishwasher by touching the controls with this option selected.
- If a cycle is running, the buttons will not respond. (except the **Power** button)
- If dishwasher is off, only the **Power** button responds.

Auto Release™

Auto Release™ is designed to improve the drying performance, which opens the door (5 to 15 minutes before a cycle is complete) in between 15 seconds and 3 minutes after the actuating signal is triggered. You can change the default settings as follows:

Auto Release™ On/Off

Using Setting Mode

- To enter Setting mode, press the **Delay Start+Sanitize** button for 3 seconds while the dishwasher is on.
- Press the **Sanitize** button until "A1" or "A0" is displayed. "A0" disables Auto Release™ Dry. "A1" enables Auto Release™ Dry. Select "A1" for better drying results.
- Press the **Delay Start** button implement your choice.

Using Toggle keys

- Press the **Lower+Hi-Temp Wash** button for 3 seconds to enable or disable Auto Release™ Dry.
 - "A0" disables Auto Release™ Dry.
 - "A1" activates Auto Release™ Dry.
- Once the door opens in the Auto Release™ Dry mode, the door cannot be closed manually for the next 2 minutes.
- The Auto Release™ Dry mode will be disabled for the **Rinse Only** cycle.



 Changing the "AutoRelease™ Dry" setting can influence drying results. Select "A1" mode for better drying results. ("A1" is the default setting.)

 After a cycle is complete, the door automatically opens to let steam out. This is normal and not a product malfunction.

Setting Mode

The Setting Mode lets you change the dishwasher's Sound, Light indicator, and AutoRelease™ Dry settings. To enter the Setting mode, press the **Delay Start + Sanitize** buttons for 3 seconds while the dishwasher is on. Press the **Sanitize** button to select a sub-setting menu and then press the **Delay Start** button to change a setting.

- **Sound Setting:** Press the **Sanitize** button until "U1" or "U0" is displayed. To change the setting, press the **Delay Start** button. "U0" turns the sound off for all cycles. "U1" turns the sound on.
The dishwasher maintains the Sound Setting you have selected until you change it.
- **Light indicator Setting:** Press the **Sanitize** button until "B1" or "B0" is displayed. To change the setting, press the **Delay Start** button. "B0" turns the light off for all cycles. "B1" turns the light on.

Delay start

When you select the Delay Start option, your dishwasher will:

- Start draining to remove remaining water at once (pre-drain).

Your dishwasher will operate the selected cycle when the delay time expires.



When using the dishwasher, try to arrange the dishes properly as described on page 16 to 19.

- You should remove food remains such as bones, fruit seeds, etc. and any other waste such as toothpicks, paper, etc. from the dishes as these may cause damage to the dishes, create noise, or cause the dishwasher to malfunction.
- Select the appropriate cycle depending on the level of soil and the type of dishes.
- Use only the proper amount of detergent and rinsing agent.



Do not wash the following items

- **Acrylic or Aluminum items:** Dishes with printed gold rim decoration may become discolored.
- **Dishes treated with adhesive:** Treated plastics, wood, ivory, copper, and tin may come loose.
- **Plastics with a temperature tolerance less than 194 °F (90 °C):** Thin plastics wash and dry poorly, and may be damaged due to elevated wash temperatures.
- **Tin:** Tin should be washed by hand and dried immediately as it may rust.
- **Wooden utensils:** Wooden items may crack.

using your dishwasher

ADJUSTING THE ANGLE OF THE PLATE SUPPORTS

You can adjust the angle of the tines in the upper rack to three different positions to match the size and shape of your dishes. To adjust the tines, grasp the handle at the back of the rack and push it left or right. See the illustration below.

In the lower rack, you can easily remove the plate support to make room for large items such as pots and pans. To remove the plate support, lift up the handles (A). To refit the plate support, align it so it is in place, and then push down on the handles (A). To fold down the fold-down tines on the lower rack, remove the rack from the dishwasher, turn the rack over, grasp the tine (B), and then adjust it backward. See the illustration below.

Upper rack

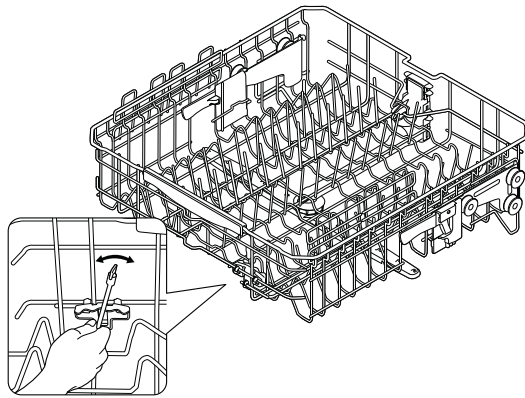

Lower rack

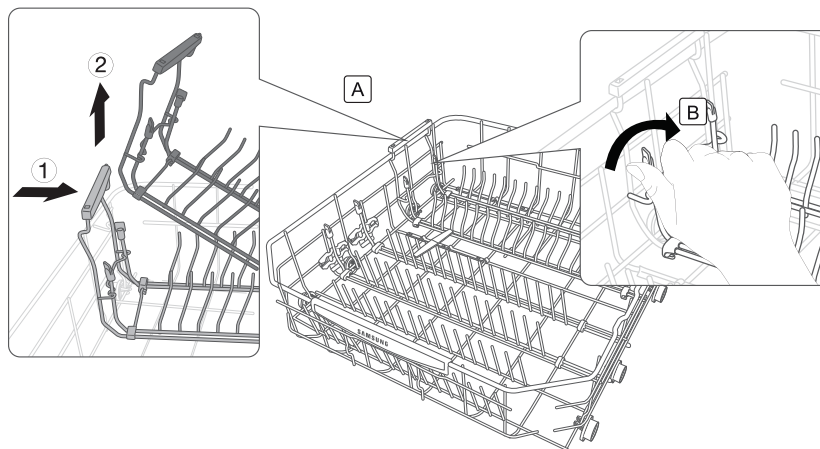

ADJUSTING THE HEIGHT OF THE UPPER RACK

You can adjust the height of the upper rack in your Samsung dishwasher so that the lower rack can accommodate larger sized dishes. With the upper rack set at the highest position, the lower rack can accommodate plates up to 12 in. (30 cm) in diameter and the upper rack can accommodate plates up to 8 in. (20 cm) in diameter.

1. To lower the upper rack by 2 in. (5 cm), pull the adjustment handles located at the left and right sides of the upper rack and push the upper rack downwards slightly at the same time.
2. To raise the upper rack, just pull the upper rack upwards. The adjuster handle will latch and the upper rack will move to the high position.

CAUTION We recommend adjusting the height of the upper rack before loading dishes into the rack. If you adjust the the rack after loading the dishes, you may damage the dishes.

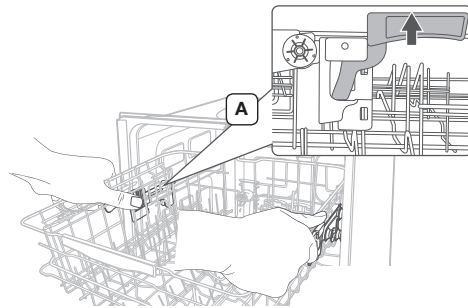

REMOVING THE UPPER RACK

Pull the upper rack towards the front and then remove it by lifting it up slightly and pulling it towards the front. See the illustrations below.

CAUTION While the upper rack is removable, it must be installed for the dishwasher to operate properly. If you attempt to operate the dishwasher without the rack, noise will occur and the dishwasher will perform poorly.

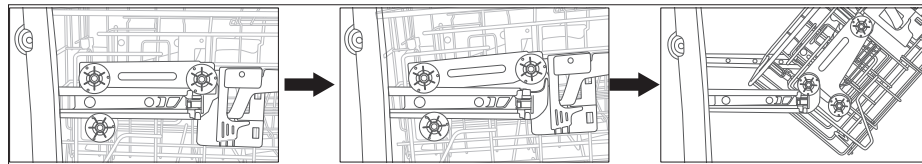

Step 1.

Step 2.

Step 3.

using your dishwasher

LOADING THE LOWER RACK

The lower rack has been especially designed for dinner dishes, soup bowls, plates, pots, lids, casserole dishes, and plates.

Load large items such as pans and pots into the dishwasher so their open sides face downwards. We recommend loading cups, stemware, and small plates into the upper rack.

See the recommended loading patterns below.



10 place setting



12 place setting

Loading the large items into the StormWash™ zone

You can load large items such as pots and pans into the StormWash™ Zone - identified by red guide lines - in the lower rack for more effective cleaning. When you select the StormWash™ option, an additional, powerful jet is activated and directed at items in the StormWash™ Zone. Make sure pot handles and other items do not interfere with the rotation of the nozzles.

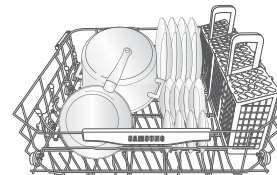

LOADING THE UPPER RACK

The upper rack has been designed for small plates, mugs, glasses, and plastic items marked "dishwasher safe". Load your plates into the dishwasher in two half rows, so that the front of each plate faces the back of the plate in front of it, and the open sides of the plates at the center of the dishwasher face each other. See the illustrations below.

Make sure the loaded dishes do not interfere with the rotation of the nozzle which is located at the bottom of the upper rack. (Check this by rotating the nozzle by hand.)

When loading dishes, pull the upper rack out sufficiently so you can load it without striking the counter above.

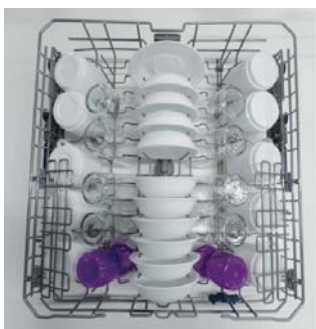

10 place setting



12 place setting

Using the glass support

You can load cups or glasses onto the glass support. This is also very convenient for washing wine glasses. Hang your wine glasses onto the pegs of the glass support.

You can fold the glass support back when it is not being used.

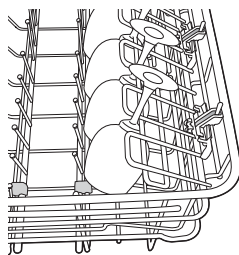

**DW80K7050 Series
DW80R5060 Series
DW80R5061 Series**

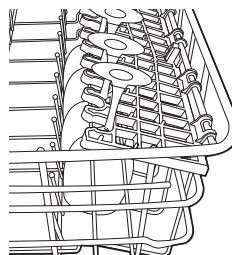

DW80K5050 Series

using your dishwasher

USING THE CUTLERY RACK

The cutlery rack consists of two compartments.

You can place each knife, spoon, or fork separately into the spoon stands in the basket's covers to prevent chipping and discoloration.

You can use the cutlery rack with the cover open. Refer to the illustration to the right.

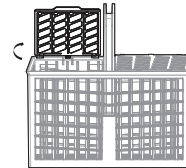

Left



Right

10 place setting



Left







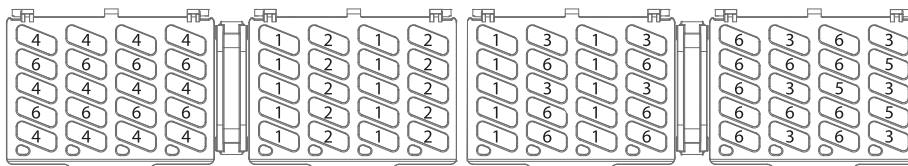

Right

12 place setting

The spoon stands as seen from above with the suggested placement of cutlery items. Match the numbers in the diagram to the numbers in the list of cutlery items below.



 DO NOT let any item extend through the bottom.

- | | |
|---|--|
|  Forks |  Knives |
|  Tea spoons |  Serving spoons and Serving forks |
|  Dinner spoons |  Remaining items |

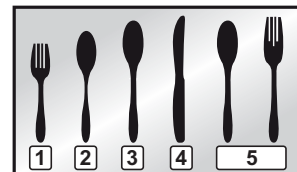

USING THE 3RD (CUTLERY) RACK (FOR APPLICABLE MODELS)

Loading the cutlery rack

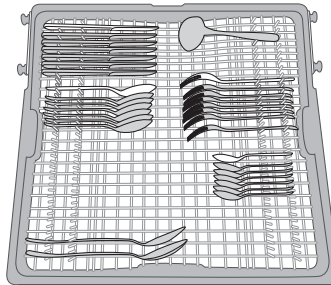

<Place items randomly or regularly.>

In addition to the standard cutlery basket in the lower rack, some models come with a cutlery rack.

The cutlery rack is best suited for flatware and cooking or serving utensils. You can place cutlery and utensils randomly or regularly on the cutlery rack.

Heavily soiled utensils or items with baked on foods should be placed in the lower cutlery basket for the most effective cleaning.

Removing the Cutlery Rack

The entire cutlery rack can be removed if more space is needed on the upper rack for larger items.

* When loading the cutlery and utensils onto the cutlery rack, make sure they do not interfere with the top nozzle of the rack. If they interfere, remove the cutlery pad and try again.

using your dishwasher

USING DETERGENT

All dishwasher cycles require detergent in the detergent compartment.

Add the correct amount of detergent for the selected cycle to ensure the best performance.

 Use dishwasher detergent only. Regular detergent produces too much foam, which may decrease the dishwasher's performance or cause it to malfunction.

 Do not swallow dishwasher detergent. Avoid breathing in the fumes. Dishwasher detergent contains irritants and caustic chemicals that can induce respiratory conditions. If you have swallowed dishwasher detergent or inhaled the fumes, seek medical attention immediately.

 Keep dishwasher detergent out of the reach of children.

Filling the detergent dispenser

1. Open the detergent dispenser flap by pushing the detergent dispenser release catch.

 The flap is always open at the end of a dishwashing cycle.

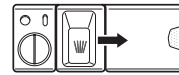
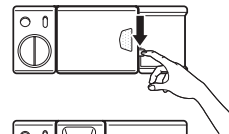

2. Add the recommended amount of detergent to the main wash detergent compartment.
3. Close the flap by sliding it to the left and then pressing it down.

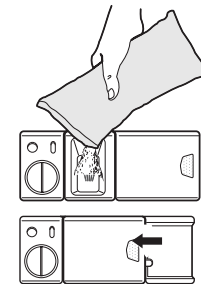

4. For better cleaning result, especially if you have very dirt items, pour a small amount (about 1/2 of an ounce or 15 g) of detergent onto the door. The additional detergent will activate during the pre-wash phase.

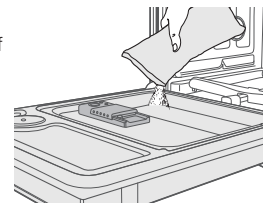

The cover opens automatically to dispense the detergent during the wash.

CYCLE	AMOUNT OF DETERGENT	
	Main wash dispenser	Onto the door for pre-wash
Auto, Normal	3/4 oz (20 g)	1/3 oz (10 g)
Heavy, Express 60'	1 oz (30 g)	1/2 oz (15 g)
Delicate	3/4 oz (20 g)	1/5 oz (5 g)

 The numbers inside the dispenser refer to grams.

Filling the rinse aid reservoir

When the Rinse Refill indicator lights up on the control panel, refill the reservoir with rinse aid. Your dishwasher has been designed to use liquid rinse aid only. Using a powdered rinse aid will clog the reservoir opening and cause the dishwasher to malfunction.

Rinse aid improves the drying performance of the dishwasher.

 Do not add regular detergent to the rinse aid reservoir.

1. Remove the rinse aid reservoir cap by rotating it counterclockwise.

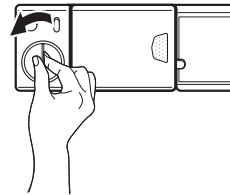

2. Fill the rinse aid reservoir with rinse aid.

 Use the viewing port when filling the rinse aid reservoir.

 Do not fill the reservoir above the full level indicator. Excess rinse aid can overflow during the wash cycle.

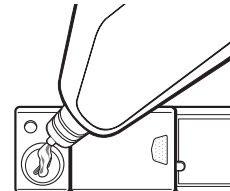

3. Turn the rinse aid indicator dial to a number between 1 and 6. The higher the number, the more rinse aid the dishwasher uses. If you are unable to rotate the rinse aid dial easily, try using a coin.

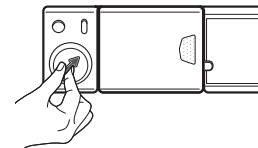

4. Close the rinse aid reservoir cap by rotating it clockwise.

cleaning and maintaining your dishwasher

Keeping your dishwasher clean improves its performance, reduces unnecessary repairs, and lengthens its life.

CLEANING THE EXTERIOR

It's best to clean spills on the outside of your dishwasher as they occur. Use a soft, damp cloth on the control panel to gently wipe away spills and dust. Do not use benzene, wax, thinner, chlorine bleach, or alcohol. These materials may discolor the inner walls and cause stains. Do not clean the dishwasher by sprinkling water over it and avoid letting water come into contact with any of the electrical parts.

 If your dishwasher has a stainless steel door panel, you can clean it with a stainless steel cleaner for Home Appliances or a similar product using a clean, soft cloth.

CLEANING THE INTERIOR

Clean the interior of your dishwasher periodically to remove any dirt or food particles. Wipe the inside of the dishwasher and the inner part of the door with a wet dishcloth. We recommend filling the detergent dispenser with dish detergent, and then running the dishwasher empty periodically using either the Normal or Express 60 cycle with the sanitize option. This will keep your dishwasher clean.

If white spots and odor are still present in your dishwasher, run the Normal cycle with the dishwasher empty and without detergent until it flushes. Then, interrupt the cycle and put an 8 ounce cup of white vinegar into the lower basket. Close the dishwasher and let the cycle finish.

 **CAUTION** Do not remove the tub front seal (the long rubber seal enclosing the opening of the dishwasher).

CLEANING THE FILTERS (DW80K7050 SERIES)

1. Turn off the dishwasher.

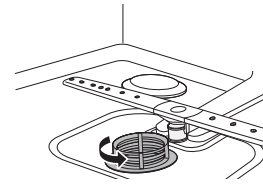

2. Rotate the filter insert counterclockwise to unfasten and then detach the filter insert.

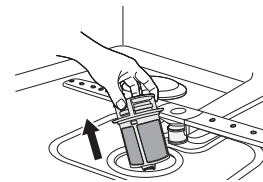

3. Remove the fine filter (flat, rectangular).

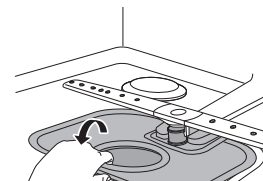

- Remove any dirt or other remains from the filters, and then rinse them under running water.

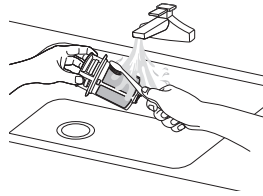

- Reassemble the filters in the reverse order of the disassembly, replace the filter insert, and rotate clockwise to the close arrow.



If the filter insert is not closed properly, its performance will be decreased.

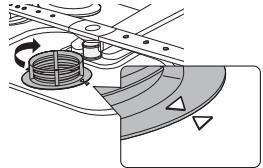

CLEANING THE NOZZLES

If your dishwasher does not seem to be cleaning adequately or the nozzles seem clogged, you can clean each of the nozzles. When removing the nozzles, take care as they may break.

Lower nozzle

- Check whether the nozzle holes are clogged by food particles.
- If cleaning is needed, remove the nozzle by pulling it upwards.
- Clean the nozzle, and then push it back into place.
- Check whether the nozzle is engaged correctly by rotating it by hand.

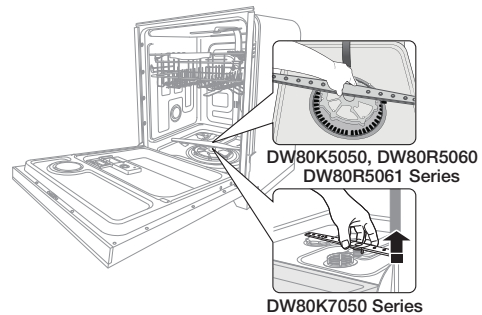

cleaning and maintaining your dishwasher

Middle nozzle

1. Pull the upper rack towards the front and remove it.
2. Check whether the nozzle holes are clogged by food particles.
3. If cleaning is needed, remove the nozzle.
4. To remove the nozzle, unfasten and remove the nut, and then remove the nozzle.
5. Clean the nozzle, re-insert it, and fasten the nut.
6. When fastening the nut, turn it firmly by hand.
7. Check whether the nozzle is engaged correctly by rotating it by hand.

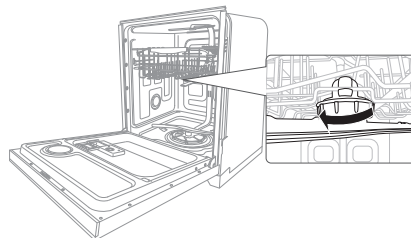

Upper nozzle

1. Check whether the nozzle holes are clogged by food particles.
2. If cleaning is needed, remove the nozzle.
3. To remove the nozzle, pull out the upper rack first, unfasten the nozzle cap by turning it counterclockwise, and then remove the upper nozzle.
4. Clean the nozzle, re-insert it, and then fasten the nozzle cap to the nozzle by turning the cap clockwise.
5. Check whether the nozzle is engaged correctly by rotating it by hand.

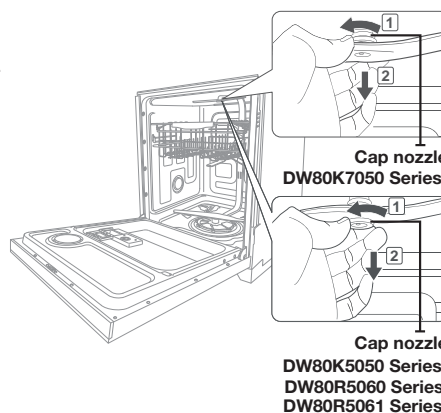

STORING YOUR DISHWASHER

If you need to store your dishwasher for an extended period of time, first drain and disconnect it. If you leave water in the hoses and internal components, you can damage the dishwasher. After draining and disconnecting the dishwasher, be sure to turn off the water supply valve and circuit breaker.

cycles

CYCLE CHART

DW80K7050 Series

Cycle	Pre-wash1	Pre-wash2	Pre-wash3	Main wash	Rinse1	Rinse2	Rinse3	Last Rinse [Sanitize]	Dry	Water [gal(ℓ)]	Time (min)
Auto	●	●	●	● 122-140 °F (50-60 °C)	●	○	○	● 136-154 °F (58-68 °C) [163 °F (73 °C)]	●	4.5-6.5 (16.9-24.7)	128-144
Normal	●	○		● 113-144 °F (45-62 °C)	●	○	○	● 136-149 °F (58-65 °C) [163 °F (73 °C)]	●	2.3-6.6 (9.0-25.1)	100-167
Heavy	●	●	●	● 149 °F (65 °C)	●	●	●	● 154 °F (68 °C) [163 °F (73 °C)]	●	7.7 (29.0)	163
Delicate	●			● 122 °F (50 °C)	●			● 149 °F (65 °C)	●	3.8 (14.3)	101
Express 60				● 122 °F (50 °C)	●			● 140 °F (60 °C) [163 °F (73 °C)]	●	3.0 (11.4)	60
Rinse only					● 104 °F (40 °C)					1.1 (4.2)	14

(● : Basic, ○ : Optional step)

DW80K5050, DW80R5060, DW80R5061 Series

Cycle	Pre-wash1	Pre-wash2	Pre-wash3	Main wash	Rinse1	Rinse2	Rinse3	Last Rinse [Sanitize]	Dry	Water [gal(ℓ)]	Time (min)
Auto	●	○		● 131-145 °F (55-63 °C)	●	○	○	● 136-154 °F (58-68 °C) [163 °F (73 °C)]	●	4.9-8.4 (18.4-31.9)	110-149
Normal	●	○		● 113-145 °F (45-63 °C)	●	○	○	● 131-149 °F (55-65 °C) [163 °F (73 °C)]	●	3.1-7.2 (11.7-27.2)	103-170
Heavy	●	●		● 149 °F (65 °C)	●	●	●	● 154 °F (68 °C) [163 °F (73 °C)]	●	8.7 (33.1)	166
Delicate	●			● 122 °F (50 °C)	●			● 149 °F (65 °C)	●	5.0 (19.0)	103
Express 60				● 122 °F (50 °C)	●			● 140 °F (60 °C) [163 °F (73 °C)]	●	3.8 (14.3)	60
Rinse only					● 104 °F (40 °C)					1.3 (4.9)	17

(● : Basic, ○ : Optional step)

05 cycles

cycles

- The numbers in parentheses in the Last Rinse column represent the temperature when you select Sanitize.
- When you select the Auto or Normal cycle, you can eliminate optional steps depending on the soil level of the dishes.
- The water consumption and wash time varies depending on the steps or options you add, and on the pressure and temperature of the supplied water.
- When you select any options, the cycle time can be changed.
- When the Rinse Aid is empty, wash time and Last Rinse temperature will be increased.

troubleshooting

CHECK THESE POINTS IF YOUR DISHWASHER...

PROBLEM	POSSIBLE CAUSE	SOLUTION
Will not start.	The door is not closed completely.	Check if the door is latched and closed completely.
	No cycle is selected.	Select a proper cycle.
	The power cable is not connected.	Connect the power cable properly.
	The water supply does not work.	Check if the water supply valve is open.
	The Control Panel is locked.	Unlock the child lock, (See page 8.)
It's taking too long with an operation or cycle.	A circuit breaker is open.	Reset the circuit breaker.
	Cold water is being supplied.	Check if the water supply line is connected to a hot water supply. (Additional time is required to heat cold water.)
There are food particles remaining on dishes. (Not cleaning properly.)	You selected an inappropriate cycle.	Select a cycle according to the number and soil level of the dishes, as directed in this manual.
	The water temperature is low.	Connect the water supply line to a hot water supply. For best performance, the temperature of the supplied water should be 120 °F (49 °C).
	Low water pressure.	The water pressure should be between 20 and 120 psi (140 - 830 kPa).
	The water is too hard.	Use high-quality, fresh detergent with rinse aid.
	Dishwasher detergent was not used.	Use automatic dishwasher detergent. We recommend a powder or gel type dishwasher detergent.
	Detergent remains in the dispenser. 	Make sure large items such as cookie sheets, cutting boards, or containers, etc. are not blocking the detergent dispenser and preventing it from opening properly. Rearrange the dishes so they do not interfere with detergent dispenser operation.
	There is no rinse aid.	Check the dispenser and add rinse aid. Use liquid type rinse aid.
	A nozzle is clogged.	Clean the nozzle. See page 23.
The dishes are improperly loaded. Too many dishes have been loaded.	Rearrange the dishes so they do not interfere with nozzle rotation and detergent dispenser operation. Load only an appropriate number of dishes. Load your dishes as recommended. (See page 16.)	

troubleshooting

PROBLEM	POSSIBLE CAUSE	SOLUTION
Leaves glasses with a dim polish.	The water supplied is soft and too much detergent was used.	Underload the dishwasher and use a rinse aid to minimize this.
	Aluminum dishes were included in the wash load.	Remove the marks on the dishes using a low sensitivity cleaner.
Leaves a yellow or brown film on the inside of the dishwasher.	This is caused by coffee and tea soils.	Remove the soils using a spot cleaner.
Does not dry dishes well.	There is no rinse aid in the dispenser.	Check the dispenser and add rinse aid. Use a liquid type rinse aid.
	The temperature of the water is low when the dishwasher is running.	Connect the water supply line to a hot water supply. Use rinse aid with the Sanitize option.
	Too many dishes have been loaded.	Proper loading of items can affect drying. Load your dishes as recommended. (See page 16.)
	Glasses and cups with concave bottoms hold water. This water may spill onto other items when unloading.	After the cycle finishes, empty the lower rack first and then the upper rack. This will prevent water from dripping from the upper rack onto the dishes in the lower rack.
	AutoRelease™ Dry mode is not in use.	Activate the AutoRelease™ Dry mode. (See page 12.)
Has a bad odor.	Water was left over from an incomplete cycle.	Insert detergent without loading dishes, and run the Normal cycle to clean the dishwasher.
	The Drain Hose is obstructed.	Contact a qualified service technician to remove any obstruction from the drain hose.
	The dishwasher is not used daily or soiled dishes are left in unit too long.	With the dishwasher empty and no detergent, place a glass with 8 ounces of vinegar upright into the lower rack, and then run a Normal cycle.
Is too noisy.	Sound is generated when the dispenser cover is open and the drain pump is operating in an early stage.	This is normal operation.
	The dishwasher is not level.	Ensure the dishwasher is level.
	Foreign material (a screw, a plastic piece) is in the pump chamber.	Contact a qualified service technician to remove foreign material from the pump chamber.
	There is a 'chopping' sound because a nozzle is bumping against the dishes.	Rearrange the dishes.

PROBLEM	POSSIBLE CAUSE	SOLUTION
Does not have a smoothly rotating nozzle.	The nozzle hole is clogged with food particles.	Clean the nozzle hole. See page 23.
	The nozzle is blocked by a dish or pot and cannot rotate.	After placing the dishes into the racks, rotate the nozzles by hand to check whether any of the dishes interfere with them.
Water won't pump out of the dishwasher.	The drain is clogged.	Contact a qualified service technician to remove any obstruction from the drain hose and check the drain pump operation.
Has a bent upper rack after loading dishes.	The dishes are not loaded properly.	Load your dishes as recommended. (See page 16.)
Cannot close the door.	AutoRelease™ Dry mode is in operation. 	Once the door opens in the AutoRelease™ Dry mode, the door cannot be closed manually for the next 2 minutes. You may close the door after 2 minutes.

troubleshooting

INFORMATION CODES

The Control Panel displays information codes to help you understand what is occurring with your dishwasher.

Code	Action
OC	Over-level water check <ul style="list-style-type: none">Functional check. Close the water supply valve and go to your house circuit breaker panel, set the dishwasher's circuit breaker switch to off, and then contact an authorized Samsung service center.
LC	Leakage check <ul style="list-style-type: none">If a water supply valve connection leak occurs, close the water supply valve and go to your house circuit breaker panel, set the dishwasher's circuit breaker switch to off, and then contact the installer to fix. If the problem continues, contact an authorized Samsung service center.
4C	Water supply check <ul style="list-style-type: none">Check if the water supply valve is closed, the water supply is suspended, or the water inlet valve or line is frozen or clogged by foreign particles. If the problem continues, close the water supply valve, and then contact an authorized Samsung service center.
5C	Drain check <ul style="list-style-type: none">After closing the water supply valve, check whether the drain hose is clogged or folded. Also, check whether drain hole inside sump is clogged. If the problem continues, contact an authorized Samsung service center.
HC	High temperature heating check <ul style="list-style-type: none">The product ensure that the temperature for hot water line is not too high and adjusts to appropriate temperature (120 °F (49 °C) - 149 °F (65 °C)) automatically. If the problem continues, go to your house circuit breaker panel, set the dishwasher's circuit breaker switch to off, and then contact an authorized Samsung service center.
3C	Pump operation check <ul style="list-style-type: none">Functional check. Turn off the dishwasher and try to start it again. If the problem continues, contact an authorized Samsung service center.

For any codes not listed above, call 1-800-SAMSUNG (726-7864)

appendix

HELPING THE ENVIRONMENT

- Your dishwasher is manufactured from recyclable materials. If you decide to dispose of it, please observe local waste disposal regulations. Cut off the power cable so that the appliance cannot be connected to a power source.
- Remove the door so that animals and small children cannot get trapped inside the appliance.
- Do not exceed the detergent quantities recommended in the detergent manufacturers' instructions.

SPECIFICATIONS

Model	DW80K7050,DW80K5050,DW80R5060,DW80R5061Series		
Type	Built-in Dishwasher	Wash capacity	15 place settings
Power	120 V~, 60 Hz only, 15 A circuit breaker	Used water pressure	20 - 120 psi (140 - 830 kPa)
Rated power uasge	Wash Motor	DW80K7050 Series : 60 ~ 100 W	
	Heater	DW80K5050,DW80R5060,DW80R5061 Series :150~190 W 1100 W	
Dimensions (Width × Depth × Height)	23 $\frac{3}{8}$ x 24 $\frac{3}{4}$ (Excluding Handle) x 33 $\frac{7}{8}$ in. [605 x 627 (Excluding Handle) x 860mm] (DW80K7050 , DW80R5061 Series) 23 $\frac{3}{8}$ x 24 $\frac{3}{4}$ x 33 $\frac{7}{8}$ in. (605 x 627 x 860 mm) (DW80K5050 , DW80R5060 Series)		
Weight	Unpacked	DW80K7050,DW80R5060, DW80R5061 Series : 101.4 lb (46 kg)	
		DW80K5050 Series : 94.8 lb (43 kg)	

warranty (U.S.A)

SAMSUNG DISHWASHER

LIMITED WARRANTY TO ORIGINAL PURCHASER WITH PROOF OF PURCHASE

This SAMSUNG brand product, as supplied and distributed by SAMSUNG ELECTRONICS AMERICA, INC. (SAMSUNG) and delivered new, in the original carton to the original consumer purchaser, is warranted by SAMSUNG against manufacturing defects in materials or workmanship for the limited warranty period, starting from the date of original purchase, of:

One (1) Year All Parts and Labor, Five (5) Years Printed Circuit Board, Racking (Labor Charges for in-home service starting from the 2nd year is customer's responsibility), and Lifetime Stainless Door Liner & Tub for leakage. If the unit cannot be repaired, Samsung will replace your unit with same or current model (that is better or equivalent in functionality) (Labor related to replacement is customer's responsibility).

This limited warranty is valid only on products purchased and used in the United States that have been installed, operated, and maintained according to the instructions attached to or furnished with the product. To receive warranty service, the purchaser must contact SAMSUNG at the address or phone number provided below for problem determination and service procedures. Warranty service can only be performed by a SAMSUNG authorized service center. The original dated bill of sale must be presented upon request as proof of purchase to SAMSUNG or SAMSUNG's authorized service center to receive warranty service.

SAMSUNG will provide in-home service within the contiguous United States during the warranty period at no charge, subject to availability of SAMSUNG authorized servicers within the customer's geographic area. If in-home service is not available, SAMSUNG may elect, at its option, to provide transportation of the product to and from an authorized service center. If the product is located in an area where service by a SAMSUNG authorized servicer is not available, you may be responsible for a trip charge or required to bring the product to a SAMSUNG authorized service center for service.

To receive in-home service, product must be unobstructed and accessible to the service agent.

During the applicable warranty period, a product will be repaired, replaced, or the purchase price refunded, at the sole option of SAMSUNG. SAMSUNG may use new or reconditioned parts in repairing a product, or replace the product with a new or reconditioned product. Replacement parts and products are warranted for the remaining portion of the original product's warranty or ninety (90) days, whichever is longer. All replaced parts and products are the property of SAMSUNG and you must return them to SAMSUNG.

This limited warranty covers manufacturing defects in materials or workmanship encountered in normal household, noncommercial use of this product and shall not cover the following: damage that occurs in shipment, delivery, installation, and uses for which this product was not intended; damage caused by unauthorized modification or alteration of the product; product where the original factory serial numbers have been removed, defaced, changed in any way, or cannot be readily determined; cosmetic damage including scratches, dents, chips, and other damage to the product's finishes; damage caused by abuse, misuse, pest infestations, accident, fire, floods, or other acts of nature or God; damage caused by use of equipment, utilities, services, parts, supplies, accessories, applications, installations, repairs, external wiring or connectors not supplied or authorized by SAMSUNG; damage caused by incorrect electrical line current, voltage, fluctuations and surges; damage caused by failure to operate and maintain the product according to instructions; in-home instruction on how to use your product; and service to correct installation not in accordance with electrical or plumbing codes or correction of household electrical or plumbing (i.e., house wiring, fuses, or water inlet hoses).

warranty (U.S.A)

The cost of repair or replacement under these excluded circumstances shall be the customer's responsibility.

Visits by an authorized servicer to explain product functions, maintenance or installation are not covered by this limited warranty. Please contact SAMSUNG at the number below for assistance with any of these issues.

EXCLUSION OF IMPLIED WARRANTIES

IMPLIED WARRANTIES, INCLUDING THE IMPLIED WARRANTIES OF MERCHANTABILITY OR FITNESS FOR A PARTICULAR PURPOSE, ARE LIMITED TO ONE YEAR OR THE SHORTEST PERIOD ALLOWED BY LAW. Some states do not allow limitations on how long an implied warranty lasts, so the above limitations or exclusions may not apply to you. This warranty gives you specific rights, and you may also have other rights, which vary from state to state.

LIMITATION OF REMEDIES

YOUR SOLE AND EXCLUSIVE REMEDY IS PRODUCT REPAIR, PRODUCT REPLACEMENT, OR REFUND OF THE PURCHASE PRICE AT SAMSUNG'S OPTION, AS PROVIDED IN THIS LIMITED WARRANTY. SAMSUNG SHALL NOT BE LIABLE FOR SPECIAL, INCIDENTAL OR CONSEQUENTIAL DAMAGES, INCLUDING BUT NOT LIMITED TO TIME WAY FROM WORK, HOTELS AND/OR RESTAURANT MEALS, REMODELING EXPENSES, LOSS OF REVENUE OR PROFITS, FAILURE TO REALIZE SAVINGS OR OTHER BENEFITS REGARDLESS OF THE LEGAL THEORY ON WHICH THE CLAIM IS BASED, AND EVEN IF SAMSUNG HAS BEEN ADVISED OF THE POSSIBILITY OF SUCH DAMAGES. Some states do not allow exclusion or limitation of incidental or consequential damages, so the above limitations or exclusions may not apply to you. This warranty gives you specific rights, and you may also have other rights, which vary from state to state.

SAMSUNG does not warrant uninterrupted or error-free operation of the product. No warranty or guarantee given by any other person, firm, or corporation with respect to this product shall be binding on SAMSUNG.

To obtain warranty service, please contact SAMSUNG at:

In USA
Samsung Electronics America, Inc.
85 Challenger Road
Ridgefield Park, NJ 07660
1-800-SAMSUNG (726-7864)
www.samsung.com/us/support

warranty (CANADA)

SAMSUNG DISHWASHER

LIMITED WARRANTY TO ORIGINAL PURCHASER

This SAMSUNG brand product, as supplied and distributed by SAMSUNG ELECTRONICS CANADA, INC. (SAMSUNG) and delivered new, in the original carton to the original consumer purchaser, is warranted by SAMSUNG against manufacturing defects in materials and workmanship for a limited warranty period of:

One (1) Year All Parts and Labor, Five (5) Years Printed Circuit Board, Racking (Labor Charges for in-home service starting from the 2nd year is customer's responsibility), and Lifetime Stainless Door Liner & Tub for leakage. If the unit cannot be repaired, Samsung will replace your unit with same or current model (that is better or equivalent in functionality) (Labor related to replacement is customer's responsibility).

This limited warranty begins on the original date of purchase, and is valid only on products purchased and used in the Canada. To receive warranty service, the purchaser must contact SAMSUNG for problem determination and service procedures. Warranty service can only be performed by a SAMSUNG authorized service center. The original dated bill of sale must be presented upon request as proof of purchase to SAMSUNG or SAMSUNG's authorized service center. SAMSUNG will provide in-home service during the warranty period at no charge, subject to availability within the contiguous Canada.

In home service is not available in all areas.

To receive in-home service, product must be unobstructed and accessible to the service agent. If service is not available, SAMSUNG may elect to provide transportation of the product to and from an authorized service center.

SAMSUNG will repair, replace, or refund this product at our option and at no charge as stipulated herein, with new or reconditioned parts or products if found to be defective during the limited warranty period specified above. All replaced parts and products become the property of SAMSUNG and must be returned to SAMSUNG. Replacement parts and products assume the remaining original warranty, or ninety (90) days, whichever is longer.

This limited warranty covers manufacturing defects in materials and workmanship encountered in normal, noncommercial use of this product and shall not apply to the following: damage that occurs in shipment; delivery and installation; applications and uses for which this product was not intended; altered product or serial numbers; cosmetic damage or exterior finish; accidents, abuse, neglect, fire, water, lightning, or other acts of nature or God; use of products, equipment, systems, utilities, services, parts, supplies, accessories, applications, installations, repairs, external wiring or connectors not supplied or authorized by SAMSUNG that damage this product or result in service problems; incorrect electrical line voltage, fluctuations and surges; customer adjustments and failure to follow operating instructions, maintenance and environmental instructions that are covered and prescribed in the instruction book; product removal and reinstallation; problems caused by pest infestations. This limited warranty does not cover problems resulting from incorrect electric current, voltage or supply, light bulbs, house fuses, house wiring, cost of a service call for instructions, or fixing installation errors. SAMSUNG does not warrant uninterrupted or error-free operation of the product.

warranty (CANADA)

EXCEPT AS SET FORTH HEREIN, THERE ARE NO WARRANTIES ON THIS PRODUCT EITHER EXPRESS OR IMPLIED, AND SAMSUNG DISCLAIMS ALL WARRANTIES INCLUDING, BUT NOT LIMITED TO, ANY IMPLIED WARRANTIES OF MERCHANTABILITY, INFRINGEMENT OR FITNESS FOR A PARTICULAR PURPOSE. NO WARRANTY OR GUARANTEE GIVEN BY ANY PERSON, FIRM, OR CORPORATION WITH RESPECT TO THIS PRODUCT SHALL BE BINDING ON SAMSUNG. SAMSUNG SHALL NOT BE LIABLE FOR LOSS OF REVENUE OR PROFITS, FAILURE TO REALIZE SAVINGS OR OTHER BENEFITS, OR ANY OTHER SPECIAL, INCIDENTAL OR CONSEQUENTIAL DAMAGES CAUSED BY THE USE, MISUSE, OR INABILITY TO USE THIS PRODUCT, REGARDLESS OF THE LEGAL THEORY ON WHICH THE CLAIM IS BASED, AND EVEN IF SAMSUNG HAS BEEN ADVISED OF THE POSSIBILITY OF SUCH DAMAGES.

NOR SHALL RECOVERY OF ANY KIND AGAINST SAMSUNG BE GREATER IN AMOUNT THAN THE PURCHASE PRICE OF THE PRODUCT SOLD BY SAMSUNG AND CAUSING THE ALLEGED DAMAGE.

WITHOUT LIMITING THE FOREGOING, PURCHASER ASSUMES ALL RISK AND LIABILITY FOR LOSS, DAMAGE, OR INJURY TO PURCHASER AND PURCHASER'S PROPERTY AND TO OTHERS AND THEIR PROPERTY ARISING OUT OF THE USE, MISUSE, OR INABILITY TO USE THIS PRODUCT. THIS LIMITED WARRANTY SHALL NOT EXTEND TO ANYONE OTHER THAN THE ORIGINAL PURCHASER OF THIS PRODUCT, IS NONTRANSFERABLE AND STATES YOUR EXCLUSIVE REMEDY.

Some states or provinces do not allow limitations on how long an implied warranty lasts, or the exclusion or limitation of incidental or consequential damages, so the above limitations or exclusions may not apply to you. This warranty gives you specific rights, and you may also have other rights, which vary from state to state or province to province.

To obtain warranty service, please contact SAMSUNG at:

In CANADA

**Samsung Electronics Canada Inc.
2050 Derry Road West
Mississauga, Ontario L5N 0B9 Canada
1-800-SAMSUNG (726-7864)
www.samsung.com/ca/support (English)
www.samsung.com/ca_fr/support (French)**

memo

memo

SAMSUNG



bit.ly/samsungdishwashers

Scan the QR code* or visit
www.samsung.com/spsn
to view our helpful
How-to Videos and Live Shows

*Requires reader to be installed on your smartphone

Questions or Comments?

COUNTRY	CALL	OR VISIT US ONLINE AT
U.S.A	1-800-SAMSUNG (726-7864)	www.samsung.com/us/support
CANADA	1-800-SAMSUNG (726-7864)	www.samsung.com/ca/support (English) www.samsung.com/ca_fr/support (French)

DD81-02025D-01